

4G/GPS Tracker



**The driver has been identified**

John Smith  
ID No. 00353



# Fleet Safety, Driver Connection

## H8 Identification Tag

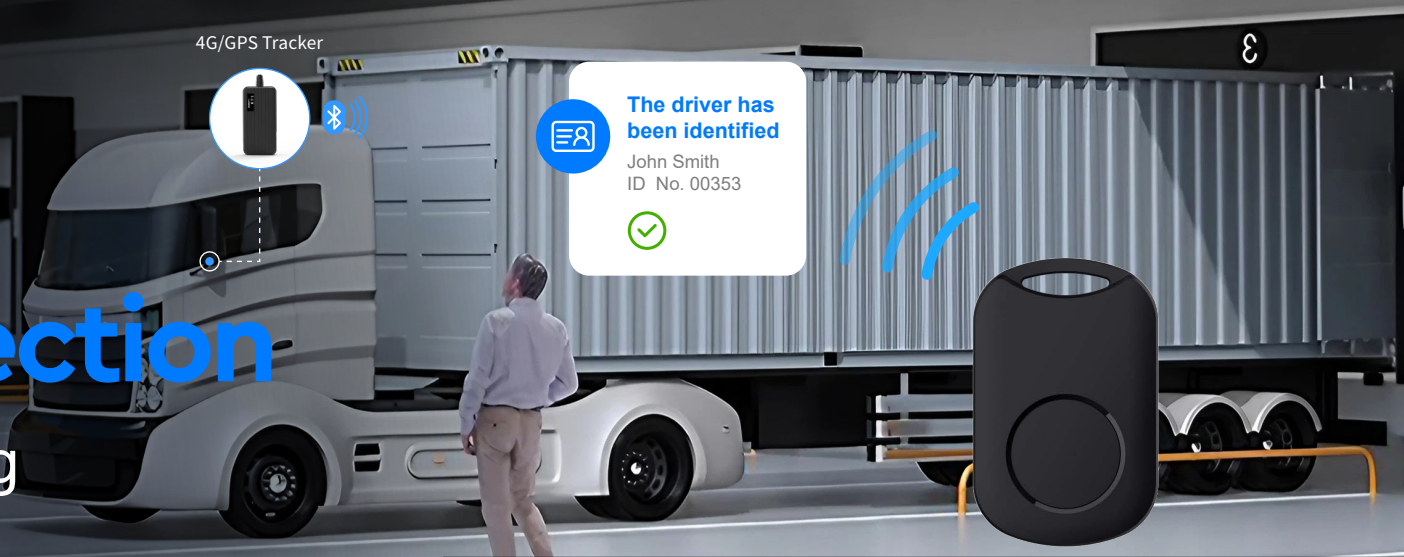

Introducing our state-of-the-art BLE Driver Identification Tag H8, designed meticulously to revolutionize driver identification and safety measures. This innovative device seamlessly combines cutting-edge technology with user-friendly features to offer an unparalleled experience in fleet management and staff security.

### Features

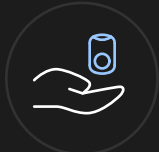

Compact and portable

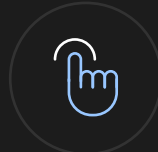

Emergency button



Replaceable battery

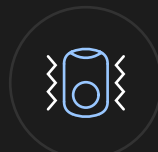

Buzzer reminder

### General specs

Connectivity:	BLE 5.0
Dimensions:	56.0*36.0*7.3 mm
Color:	Black
LED:	Red
Button:	Yes
Waterproof:	IP65
Sensor:	Accelerometer   buzzer (optional)
Battery capacity:	220mAh   replaceable battery
Battery lifespan:	1.5 years in default settings
Operating temperature:	-20 C to +60 C
Transmission range:	150m (in open area without obstacles)
Installation:	Lanyard
Certification:	FCC   CE   RoHS   REACH

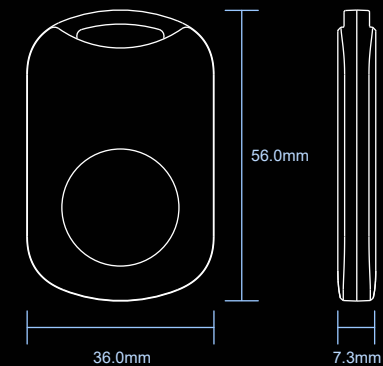

### Application scenarios

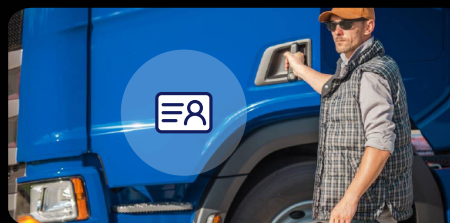

Driver Identification



Driver Safety